

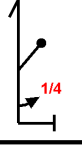

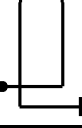



Known

Standard

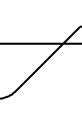
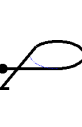
Pilot ID #

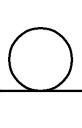
Flight #

| No | Symbol | Catalog No | K | Tot K | Score | Remarks |
|----|---|-------------------|---------|-------|-------|---------|
| 1 |  | 1.6.3 9.11.1.5 | 10 4 | 14 | | SF 3 |
| 2 |  | 5.1.1 9.1.5.1 | 17 2 | 19 | | SF 5 |
| 3 |  | 8.1.1 | 13 | 13 | | SF 7 |
| 4 |  | 7.2.1 9.1.3.2 | 6 4 | 10 | | SF 7 |
| 5 |  | 8.37.3 9.1.3.2 | 10 4 | 14 | | SF 7 |
| 6 |  | 2.1.3 | 5 | 5 | | SF 2 |
| 7 |  | 2.2.3 | 3 | 3 | | SF 2 |
| 8 |  | 7.21.3 9.4.4.2 | 14 5 | 19 | | SF 7 |
| 9 |  | 7.5.1 | 10 | 10 | | SF 7 |
| 10 |  | 1.1.1 9.1.3.4 | 2 8 | 10 | | SF 7 |

| Item | K | Score |
|-------------|----|-------|
| Positioning | 15 | |

| PENALTIES | Item | Score |
|---------------|---------------|-------|
| | Interruptions | |
| | Insertions | |
| | Too high | |
| | Too low | |
| | Outs | |
| | Other | |
| Disqual Fig # | | |

| | |
|----------|--|
| T/O time | |
| End time | |

| Fig K |
|-------|
| 117 |

| Total K |
|---------|
| 132 |

| Judges Details |
|----------------|
| Signature |
| Name |
| Number |



Olan v5.10 © M. Golan http://www.aerobatics.org.il/olan

Pilot

A/C



| | | | |
|------------|-------|----------|----------|
| DONAC 2010 | | FORM B | |
| Pilot ID # | Known | Standard | Flight # |

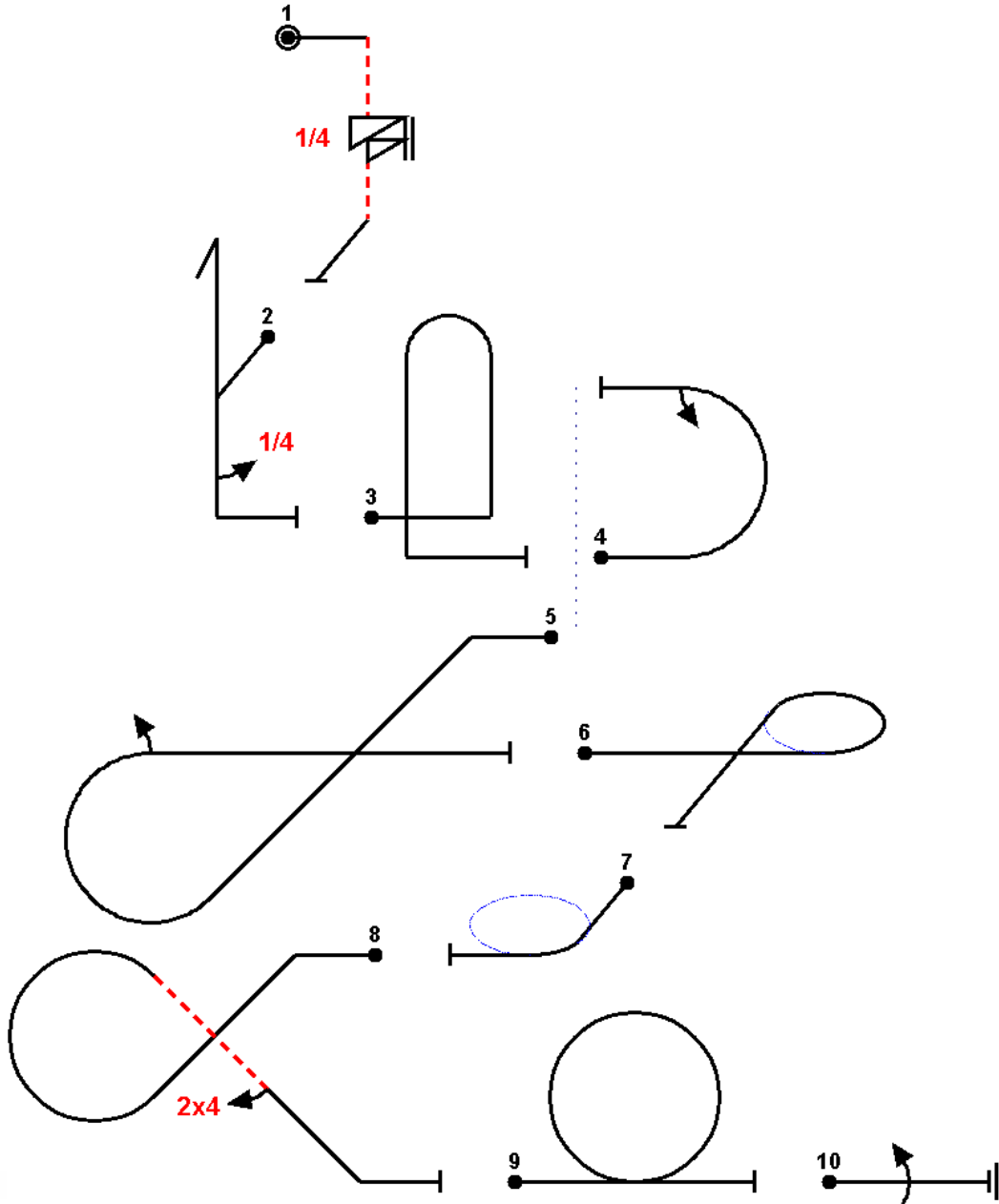
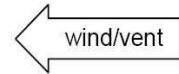

| No | Catalog No | K | Tot K |
|----|------------|----|-------|
| 1 | 1.6.3 | 10 | 14 |
| | 9.11.1.5 | 4 | sf 3 |
| 2 | 5.1.1 | 17 | 19 |
| | 9.1.5.1 | 2 | sf 5 |
| 3 | 8.1.1 | 13 | sf 7 |
| 4 | 7.2.1 | 6 | 10 |
| | 9.1.3.2 | 4 | sf 7 |
| 5 | 8.37.3 | 10 | 14 |
| | 9.1.3.2 | 4 | sf 7 |
| 6 | 2.1.3 | 5 | sf 2 |
| 7 | 2.2.3 | 3 | sf 2 |
| 8 | 7.21.3 | 14 | 19 |
| | 9.4.4.2 | 5 | sf 7 |
| 9 | 7.5.1 | 10 | sf 7 |
| 10 | 1.1.1 | 2 | 10 |
| | 9.1.3.4 | 8 | sf 7 |

---Total K= 117 ---

Total K = 117 (3k@7,19k@2)

Olan v5.10 © M. Golan <http://www.aerobatics.org.il/olan>

Cannot test this sequence type: baea.standard.known

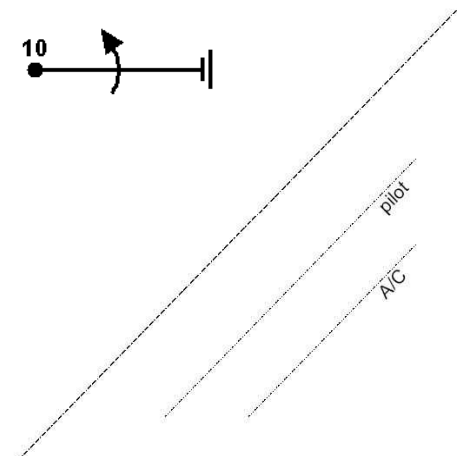



| | | | |
|------------|-------|----------|----------|
| DONAC 2010 | | FORM C | |
| Pilot ID # | Known | Standard | Flight # |

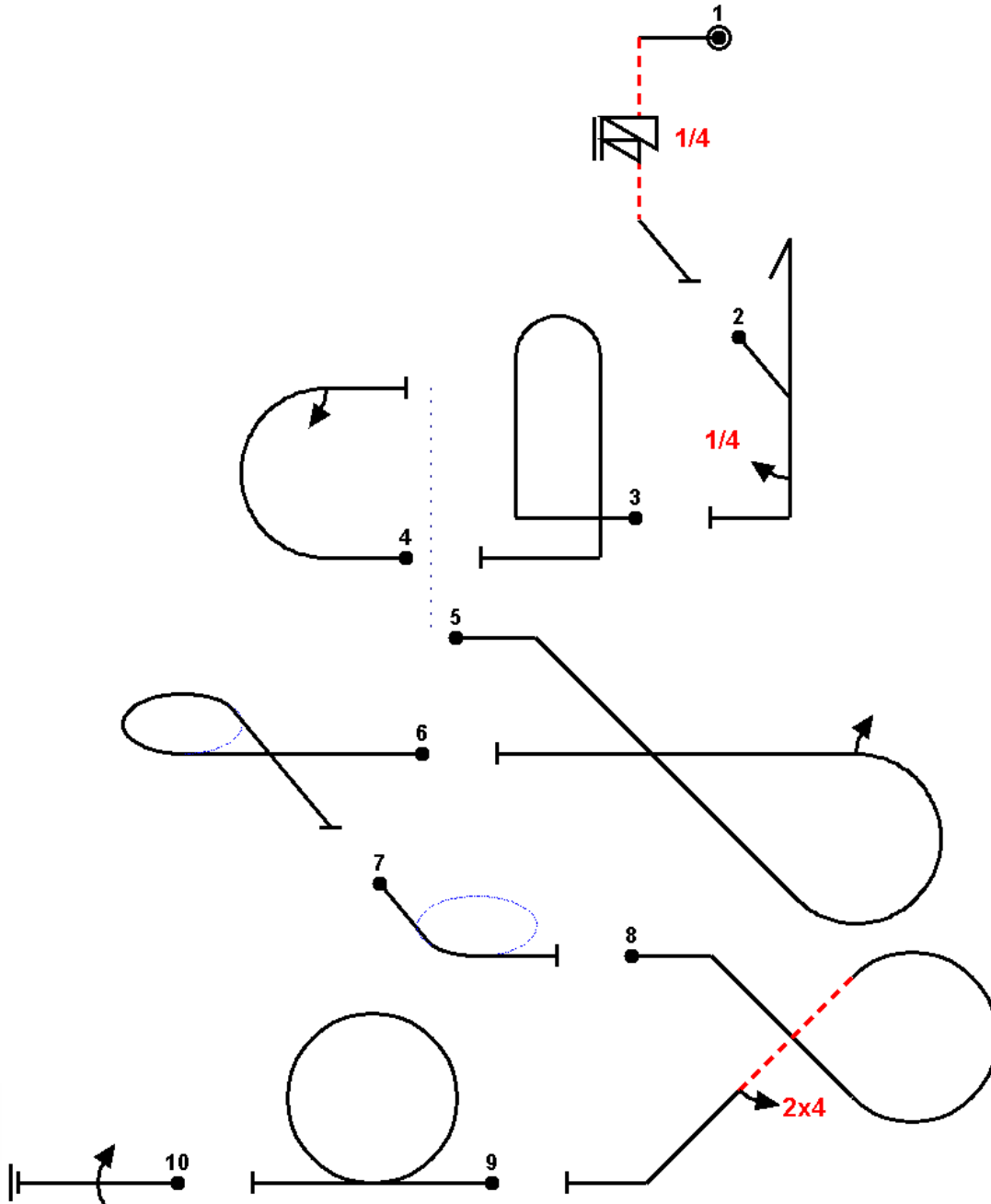

Total K = 117 (3k@7,19k@2)

Olan v5.10 © M. Golan <http://www.aerobatics.org.il/olan>

Cannot test this sequence type: baea.standard.known

