

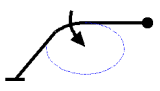
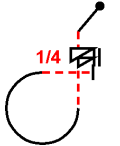
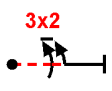
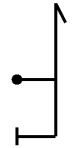
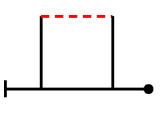
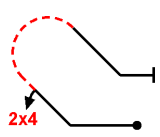
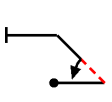
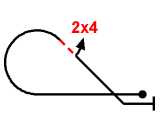

Free

Intermediate

Pilot ID #

Flight #

No	Symbol	Catalog No	K	Tot K	Score	Remarks
1		1.1.1 9.9.3.4	2 11	13		
2		2.3.1	14	14		
3		8.34.3 9.11.1.5	13 4	17		
4		1.1.4 9.2.3.6	2 12	14		
5		5.1.1	17	17		
6		7.7.1	14	14		
7		8.19.1 9.4.2.2	14 7	21		
8		1.11.1 9.1.2.2	9 6	15		
9		8.42.1 9.4.4.2	10 5	15		
10		1.1.3 9.1.3.1 9.4.3.3	2 2 8	12		

Item	K	Score
Positioning	20	
PENALTIES	Interruptions	
	Insertions	
	Too high	
	Too low	
	Outs	
	Other	
Disqual Fig #		
T/O time		
End time		

Fig K
152

Total K
172

Judges Details

Signature

Name

Number



_____ pilot

_____ A/C



DONAC 2009

FORM B

Pilot ID #

Free

Intermediate

Flight #

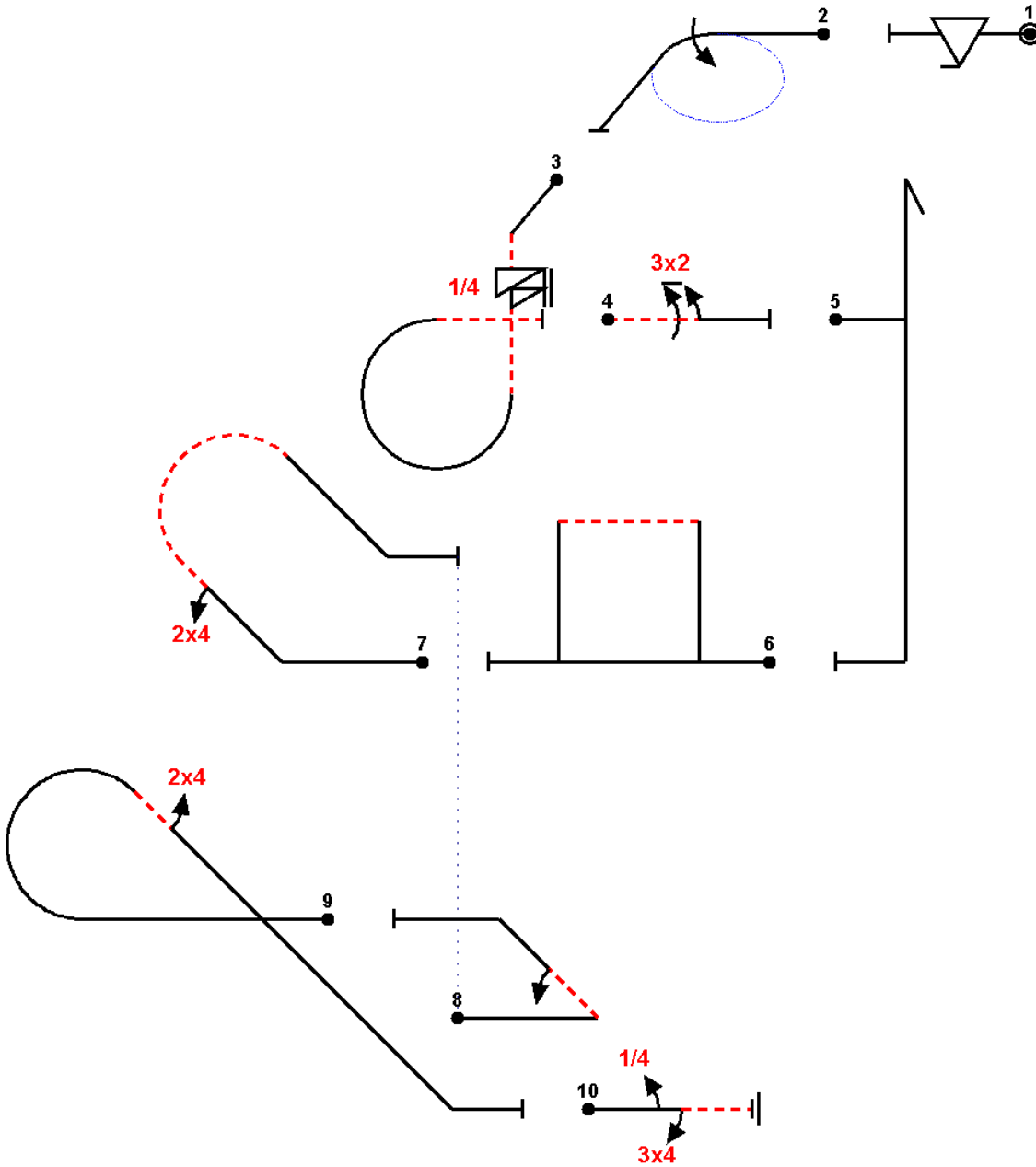
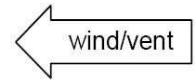

Total K = 152 (12k@10,21k@7)

Olan v5.10 © M. Golan http://www.aerobatics.org.il/olan

Sequence [baea intermediate free] Verified OK: 10 Figures, 152K (but Kmax=160)

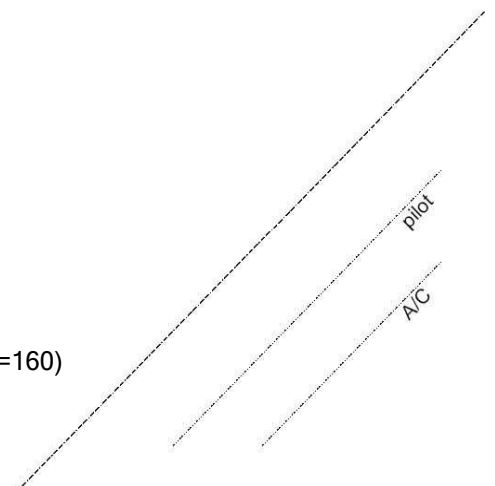



DONAC 2009		FORM C	
Pilot ID #	Free	Intermediate	Flight #

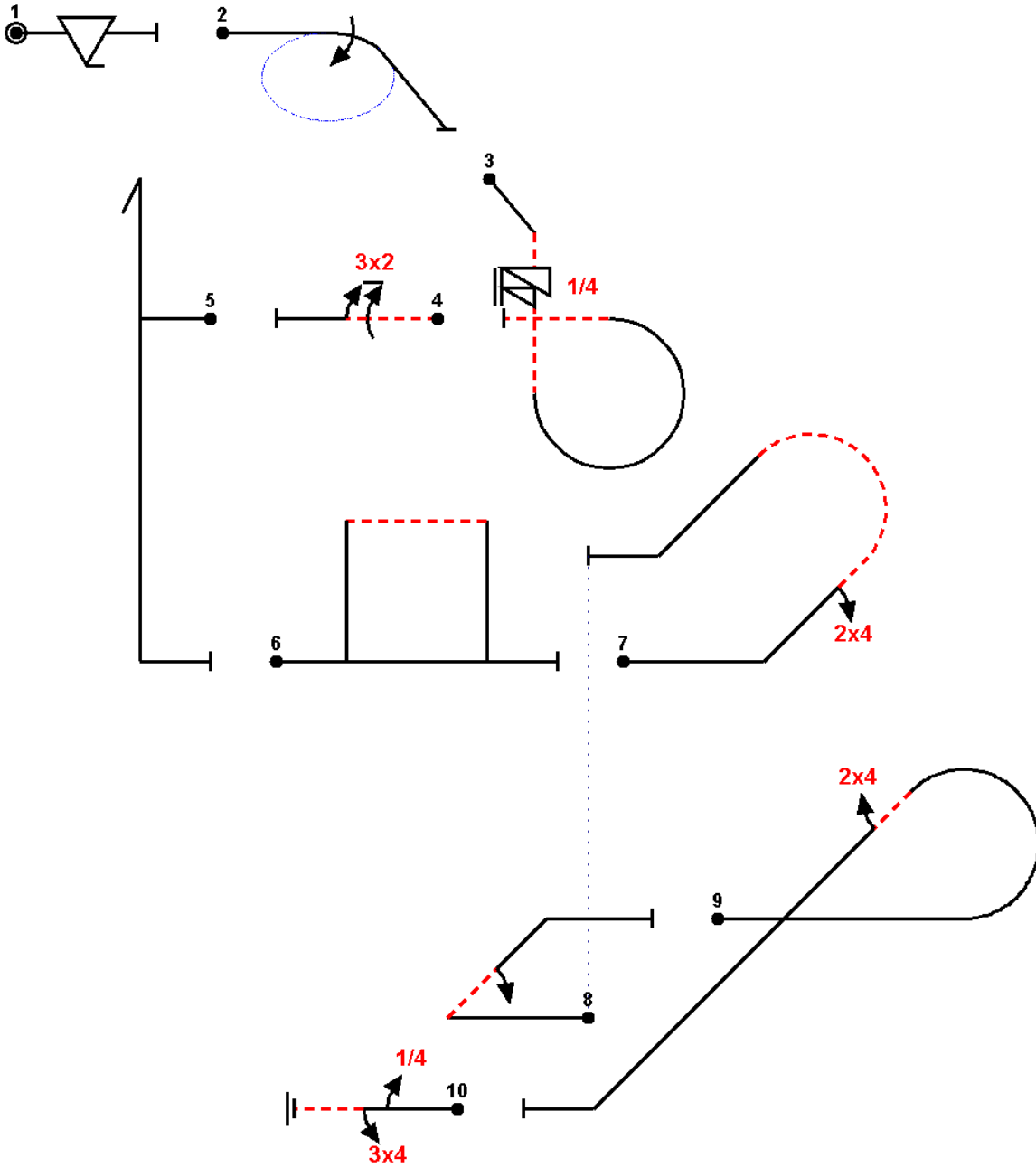

Total K = 152 (12k@10,21k@7)

Olan v5.10 © M. Golan <http://www.aerobatics.org.il/olan>

Sequence [baea intermediate free] Verified OK: 10 Figures, 152K (but Kmax=160)

